

Data Collector

DC100

Sophisticated, flexible instrumentation technology for cost-effective data logging and data acquisition. DARWIN Data Acquisition and Recording Windows, now and in the future.



DARWIN

Data Acquisition and Recording Windows



Internet
Yokogawa Electric WWW server:
<http://www.yokogawa.co.jp/Measurement/English/>

Powerful Memory, Simple, Lightweight, and Compact

Whether in the field or laboratory, the DC100's memory function is ideal for all data acquisition and recording needs.

The DC100 features a large display with a whole range of functions, allowing you to monitor data while storing them in memory. With its sophisticated memory, the DC100 offers simple data acquisition and recording in a single device, yet it's still fully portable and packed with features. No PC needed. No chart paper. No environmental impact. A cost-effective solution to your measurement needs.

DC 100

Stand-alone Model

Suitable for small-scale data logging, with a portable, lightweight design that fits anywhere. Quick and easy data logging – a handy data collector!

- Measuring interval: 500 ms/40 channels minimum
- Number of input channels: 10 to 40 channels. Various I/O modules are directly connected to the main unit.
- Compact and light weight (Depth : approx.20cm / Weight : approx.5kg)
- AC V and DC V powered models available.



● Flexible Expandability

From 10 to 300 channels, the DC100 can be flexibly modified and expanded. It handles a variety of input signals such as DC voltages, thermocouples, RTDs, contacts, power monitors, pulses, strains, and DC currents (mA).

● Dependable Durability

Durability against harsh environments is assured by Yokogawa's unique technologies such as the planar transformer and high-breakdown-voltage solid-state relay. The DC100 also complies with various international safety standards.

● Effective Data Processing

The various memory functions (memory size: 1, 2, or 4 MB: specified when ordering) allow effective data acquisition and recording. Data can be transferred to a personal computer while making a backup in the memory. The standard features include a 3.5-inch floppy disk drive and DAQ 32 software.

DC 100

Expandable Model

The expandable model consists of a main unit and subunits connected by the DARWIN cables, and can be expanded to handle up to 300 channels of measuring points.

- Measuring interval: 500 ms/300 channels minimum
- Number of input channels: 10 to 300 channels. Expansion and modification via subunits.
- Expandability: Up to six subunits can be connected to the main unit. The cable length between the main unit and subunits can be extended up to 500 m.
- AC V and DC V powered models available.

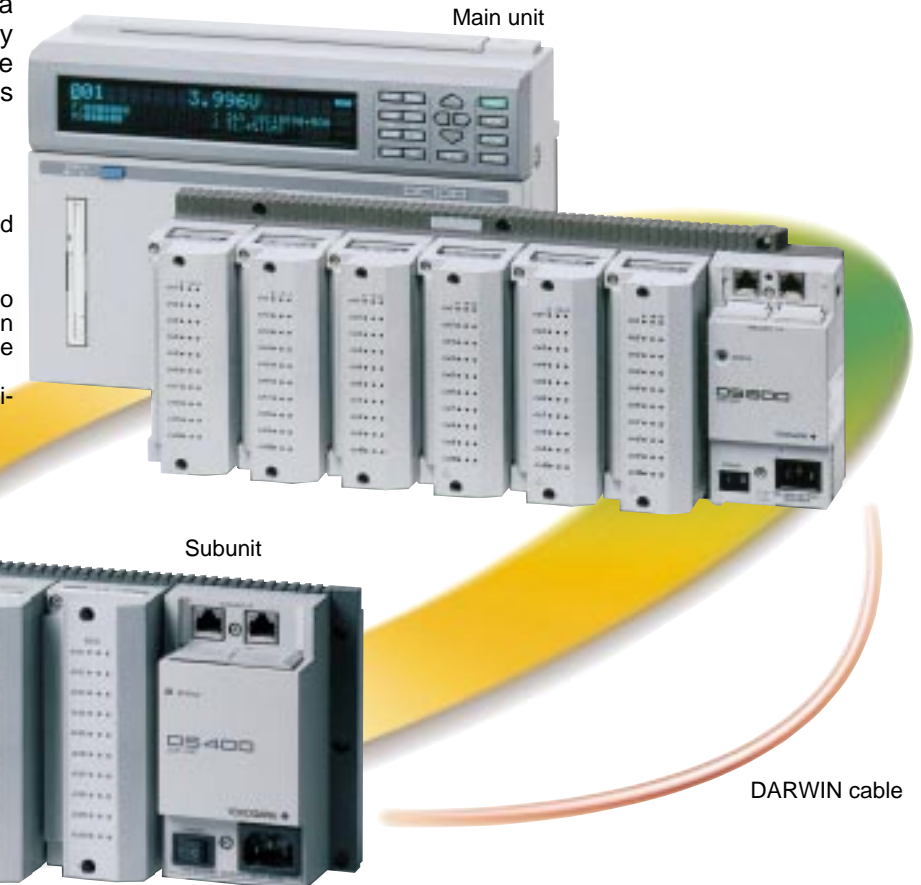

● External Mass Storage Interface (/C5)

The external mass storage interface (SCSI) option is a communication interface for saving files created in the DC100 internal RAM to the MO / Zip / Jaz / PD disk.

● Report Function (/M3)

Report files can be created hourly, daily, monthly or at designated time/date independently.

● Complete Application Software

In addition to Yokogawa's original software packages such as InTouch for DARWIN and DARWIN DAQ 32, a huge range of software packages for DARWIN as well as driver software such as LabVIEW®, FixDmacs®, and InTouch® can be used.

The DC100 is the perfect choice ...



■ When changing the data-recording media from paper to memory to maximize the usefulness of the data and yet minimize cost.



■ When data in the field needs to be monitored at the same time as acquiring and recording it using a personal computer.



■ When errors might occur during on-line data acquisition and recording using a PC or to make a backup of data in case of a power failure.



■ For unattended data acquisition and long-term recording without or with a personal computer.



■ For vehicle-mounted tests which require portability and for data measurement during transportation.



■ For troubleshooting power facilities, distribution panels and heavy machinery.

DC100 Stand-alone Model: Structural Simplicity

Overview of Standard Model

The DC100 Stand-alone model weighs just 5 kg with the full four I/O modules installed. In addition, since its depth is just 20 cm with modules (10 cm without modules), you can take it anywhere with ease. With its advanced memory functions, the DC100 stand-alone model offers simple data acquisition and

recording by combining the functionality of hybrid recorders and PC-based data loggers, yet offers superb portability and mobility, environment-friendly operation without PC or chart paper, and cost-effective, flexible data measurement.

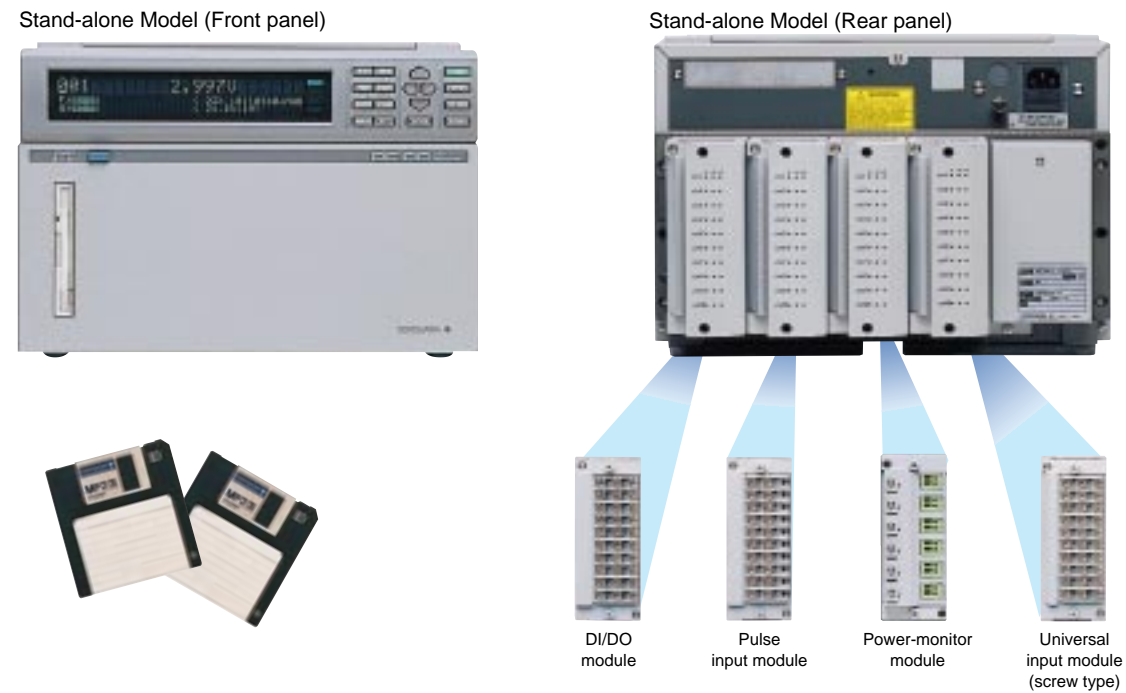

Comparison of Expandable and Stand-alone Models

Model	Data collector DC100	
	DC100 stand-alone model	DC100 expandable model
Features	Integrated construction up to 40 channels. Portable and suitable for small-scale data logging.	Expandable up to 300 channels. Connecting subunits to the main unit allows multi-channel measurement with a minimum amount of wiring.
Number of input channels Expansion, change	10 to 40 channels; Channels can be added in increments of 10 channels, and the types of modules are interchangeable.	10 to 300 channels; Channels can be added in increments of 10 channels, and the types of modules are interchangeable.
Input types	voltage, temperature, contact, power, strain, pulse, direct current (mA)	
Main unit I/O connections	Input modules; Communications module; DI/DO module; Alarm output module	(Input module connected to the subunit); Communications module; DI/DO module; Alarm output module
Subunit connections, and remote measurement distance	Not applicable	Up to six subunits can be connected; 500 m max.
Subunit I/O connections	Not applicable	Input module; Alarm output module; DI/DO module
Extension module	Not available	Available
Maximum scanning speed	0.5 s/all channels	0.5 s/all channels
Alarm contact output modules	Main unit: 10 to 30 points	Main unit: 10 to 30 points Subunits: 10 to 300 points (total 300 points max.)
Mathematical operation channels	max. 30 channels	max. 60 channels

DC-power Model

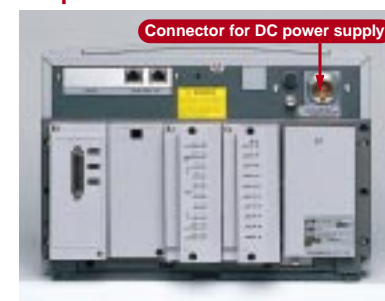

Handy DC power supply for vehicle mounted data acquisition and recording. Included AC adapter (DV500).



DC100 Expandable Model: Versatile and Cost Effective

Overview of Expandable Model

The DC100 expandable model is a next-generation data collector that can evolve to suit changing business needs. Select from the wide range of I/O modules and communication modules and install them yourself — this is true design flexibility. The I/O channels can be

expanded and modified according to your needs. This not only allows you to build up a data acquisition and recording system as your application needs grow, but the architecture also requires less initial investment.

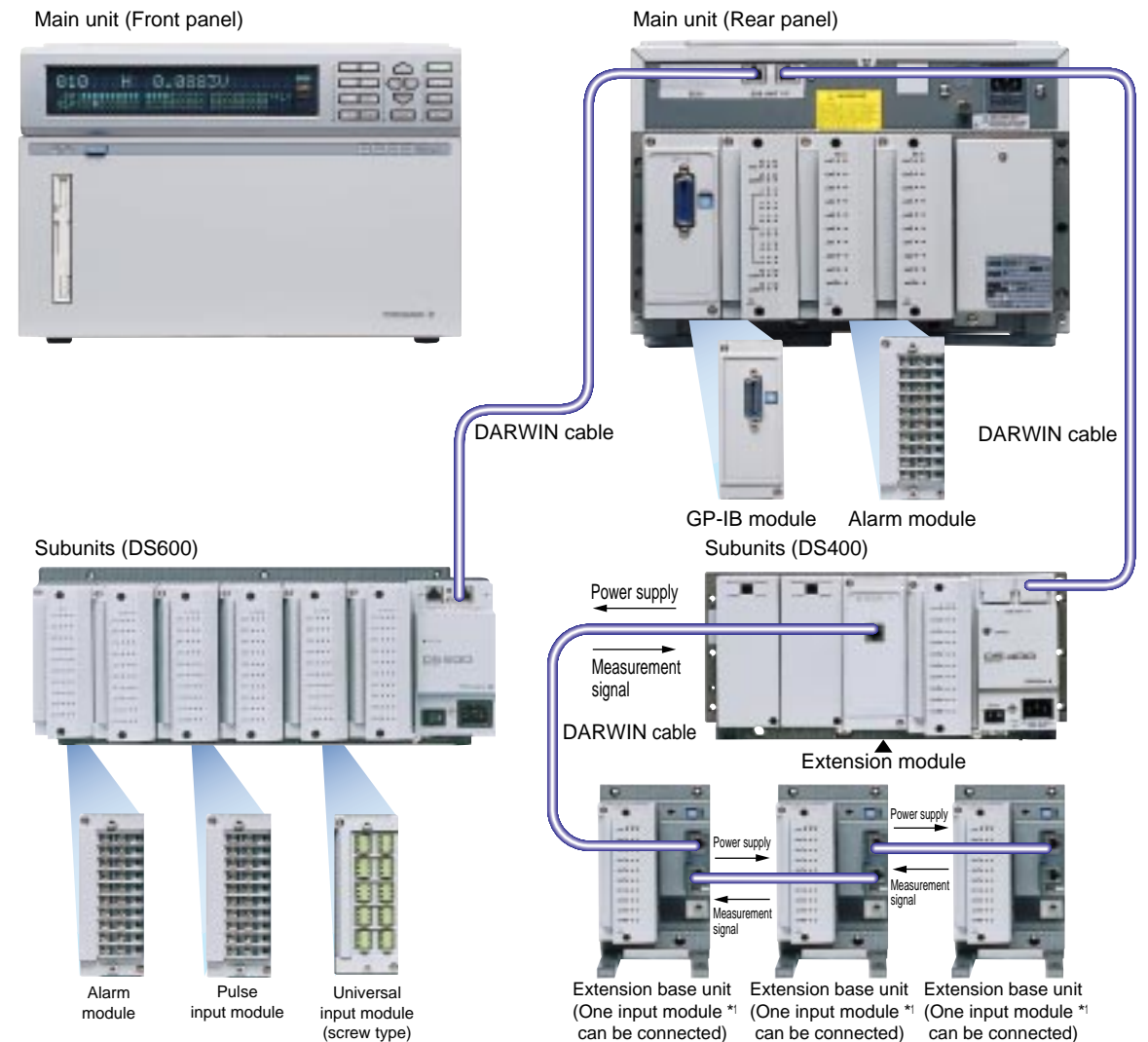

Flexible, Distributed, Remote Data Acquisition and Recording System

The DC100 expandable model consists of a main unit, subunits, input/output and communications modules. By connecting the main unit to multiple subunits with the DARWIN cable of up to 500 m total length, you can easily configure a recording/data acquisition environment ranging from 10 to 300 channels. Another key feature is its ability to scan up to 300 channels every 500 ms.

Main Unit (DC100-2)

Data are measured by the various input modules installed in the distributed subunits and are acquired and stored in the memory of the main unit. Or, by dividing the memory into multiple data files of specified data lengths or of identical sizes, the measured data can be acquired and stored in a data file while transferring another data file to an external memory device. Furthermore, by connecting a communication module such as the GP-IB, RS-232C, RS-422A/485 or Ethernet module, data can be transferred in real-time to a PC at the same time as they're being captured into the DC100 memory.

Subunit (DS400 or DS600, for DC100 expandable model)

A subunit acts as an interface for connecting the main unit of the DC100 expandable model to one or several input modules. There are two types of subunits, the DS400 which permits connection of up to four input and output modules, and the DS600 which permits connection of up to six input and output modules.

*1: Universal or DCV/TC/DI input module available

Wide Variety of Modules

Input / Output / Communication Module Groups

DU100 Universal Input Modules

DCV/TC/RTD/DI

(10ch Screw type) (10ch Clamp type) (20ch Screw type)(Clamp type available) (30ch Screw type)(Clamp type available)

DU200 DCV/TC/DI Input Modules

(20ch Screw type) (30ch Screw type)

DU300 mA Input Modules

(10ch Screw type)

DU400 Power Monitor Modules

(3 phase) (Single phase)

DU500 Strain Input Modules

(120 Ω bridge resistor type) (350 Ω bridge resistor type) (NDIS terminal type)

DU600 Pulse Input Modules

(10ch Screw type)

DU700 DI Input Modules

(10ch Screw type)

DT100 DI/DO Modules

(10ch Screw type)

DT200 Alarm Output Modules

(10ch normally open contacts) (4ch NO-C-NC contacts)

DT300-11 GP-IB Communication Module

DT300-21 RS-232-C Communication Module

DT300-31 RS422/485 Communication Module

(Screw Terminal)

DT300-41 Ethernet Communication Module

(10 Base-T)

Input Module

The input module is a small remote multiplexer that A/D-converts the measured signals every 500 ms or 2 sec.* The input signals include not only DC voltage and temperature, but also contact, power monitor, pulse, strain and DCA (mA) signals.

*: If input modules with different measurement intervals are mixed, the measurement interval is that of the longest interval input module.

●Universal Input Module

The universal input module permits measurement of DC voltages between 20 mV and 50 V, thermocouple inputs, RTD inputs, and contact signals in up to 500-ms intervals for the 10ch module. Other cost-effective universal input modules are available that measure data from 20 or 30 channels in 2-second intervals, and low-cost dedicated input modules that accept voltages and thermocouple outputs.

●Power monitor Module

The power monitor module receives AC voltage or current input signals and measures RMS values, active power, apparent power, reactive power, frequency, power factor and phase angle. The minimum measurement interval (data update cycle) is 2 seconds.

●Pulse Input Module

The pulse input module receives TTL or contact signals from a flowmeter or tachometer, and counts and integrates the number of pulses. The minimum measurement interval is 0.5 second and the data update cycle is 1 second.

●Strain Measurement Module

The strain measurement module measures static strain, and comes in two types. One incorporates a 120 or 350 Ω bridge resistor, the other is for connecting an external bridge box. One module enables data in 10 channels to be measured, although it takes up two slots. The minimum measurement interval (data update cycle) is 500 ms.

●Direct Current (mA) Module

A shunt resistor (100 Ω) is pre-installed to measure DCmA signals.

●Digital Input (DI) Module

The DI module is designed to measure contact signals on 10 channels. With channel-to-channel isolation, this module can even accept contact signals of differing common-mode voltages. Designed exclusively for use with contact signals, the DI module offers exceptional cost performance.

Example of Modules Attached to a Subunit

- ① 10ch universal input module (screw)
- ② 10ch universal input module (clamp)
- ③ Power monitor module (3 phase)
- ④ Strain input module (120 or 350Ω installed)
- ⑤ Pulse input module

Extension module

Using an extension module, you can supply power directly from a subunit for each input module^{*1} mounted on an extension base unit. Also, connecting an extension module on a subunit allows connection of up to three input modules as well as three extension base units, over a distance of up to 30 m.

*1: 10ch universal input module or 10ch DCV/TC/DI input module



DV100 Example of a DV100 Extension Module Connected to Extension Base Units



Dedicated cable



Cable adapter (DV250)



Strain conversion cable (DV450)



Panel mounting kits

General purpose communications module

You can connect a GP-IB, RS-232-C, RS-422A/RS-485 or Ethernet general purpose communications module to the back panel of the main unit. All measured data is transferred in real time via the installed communications module.

DI/DO module

This module enables the DC100 data collector to be controlled* from a remote location, and also outputs the chart end and recorder fail signals to your external annunciator.

*Remote control functions:

- Start and stop memory sampling
- Control statistical calculation interval

Alarm output module

This is a 4-channel or 10-channel output module which outputs contact alarm signals according to preset conditions. You can set four alarm levels per channel (choose from upper limit, lower limit, delta high limit, delta low limit, or rate-of-change). You can also install alarm output modules on the subunits.

Versatile Memory

Instead of PC-based, hard-disk data acquisition and the recording mechanism of a hybrid recorder, a large memory (1, 2, or 4 MB, specified when ordering)

is provided. The DC100's versatile memory system offers sophisticated data acquisition and recording by simple operations.

"Single memory" — using the entire memory as one data file

Data acquisition and recording are performed with the entire memory used as a single data file (file size : up to 1MB). Simply pressing the START key starts data acquisition and recording until the specified length of data has been recorded.

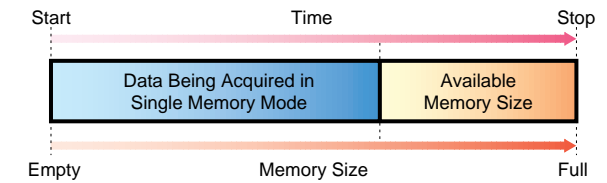

"Rotary memory" — automatically deleting and updating the oldest file

When all the divided data files become full, the data file containing the oldest data is automatically updated with new data and data acquisition and recording continues.

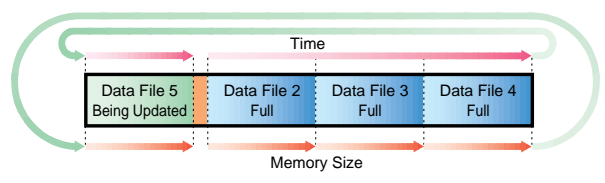

"Repeat memory" — continuous data saving

The memory is divided into multiple data files for data acquisition and recording. When the first file becomes full, the next file is selected automatically and used to record data. There are two ways of dividing the memory.

- Dividing the entire memory into 2, 4, 8, or 16 files of identical size

Example: When dividing into four files

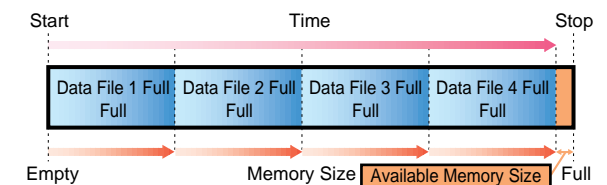

- Dividing the entire memory arbitrarily by specifying the data length of each file

Example: When making a file of 1 MB

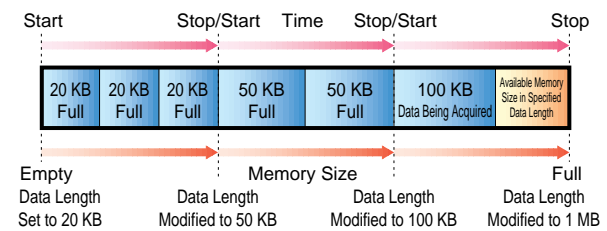

Continuous data acquisition and recording using external medium

When performing data acquisition and recording with the divided memory, a full file of recorded data can be transferred to a floppy disk while data acquisition and recording continues with the next file. The data file which was copied to the floppy disk is then updated and will be used for recording new data.

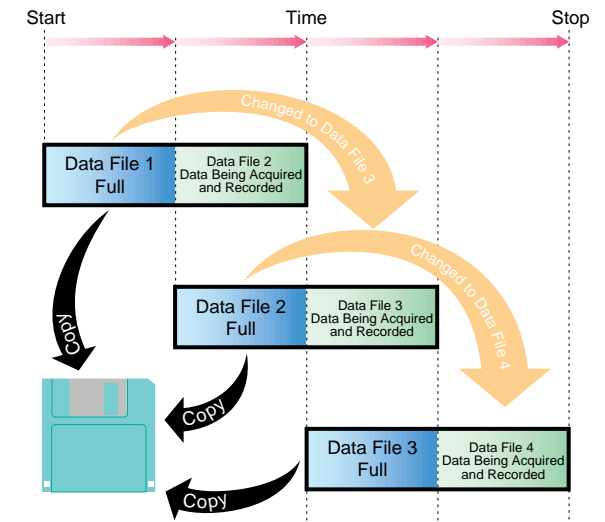

Setting condition	Stand-Alone Type			Expandable Type			
	Measurement channels 1ch+Computation channels 0ch	Measurement channels 10ch+Computation channels 0ch	Measurement channels 20ch+Computation channels 0ch	Measurement channels 60ch+Computation channels 0ch	Measurement channels 100ch+Computation channels 0ch	Measurement channels 100ch+Computation channels 60ch	
Memory size	1MB	2MB	4MB	1MB	2MB	4MB	
	Data saving time (Approx : □□□d(days) : □□h(hours) : □□m(minutes) :)						
Sampling Period	0.5 sec	18h : 2m	1d : 12h : 20m	3d : 00h : 34m	1h : 8m	2h : 17m	4h : 36m
		5h : 32m	11h : 8m	22h : 19m	41m	1h : 24m	2h : 48m
		3h : 8m	6h : 17m	12h : 37m	19m	38m	1h : 17m
		1h : 40m	3h : 21m	6h : 44m	14m	28m	57m
1 sec	41m	1h : 24m	2h : 48m	10m	20m	40m	
	1d : 12h : 00m	3d : 00h : 27m	6d : 00h : 9m	2h : 16m	4h : 35m	9h : 12m	
	11h : 5m	22h : 17m	1d : 19h : 39m	1h : 23m	2h : 48m	5h : 37m	
	6h : 15m	12h : 35m	1d : 1h : 14m	38m	1h : 17m	2h : 35m	
2 sec	2h : 45m	6h : 43m	13h : 29m	28m	56m	1h : 54m	
	1h : 57m	2h : 48m	5h : 37m	20m	40m	1h : 21m	
	3d : 00h : 9m	6d : 00h : 54m	12d : 00h : 19m	4h : 33m	9h : 10m	18h : 24m	
	22h : 10m	1d : 20h : 34m	3d : 16h : 19m	2h : 47m	5h : 36m	11h : 15m	
5 sec	12h : 30m	1d : 1h : 11m	2d : 2h : 28m	1h : 16m	2h : 35m	5h : 11m	
	6h : 40m	13h : 27m	1d : 2h : 59m	56m	1h : 53m	3h : 48m	
	2h : 47m	5h : 36m	11h : 15m	40m	1h : 21m	2h : 43m	
	7d : 12h : 23m	15d : 2h : 15m	30d : 4h : 48m	11h : 24m	22h : 57m	1d : 22h : 2m	
10 sec	2d : 7h : 28m	4d : 14h : 49m	9d : 4h : 17m	6h : 57m	14h : 1m	1d : 4h : 8m	
	1d : 7h : 20m	2d : 13h : 57m	5d : 6h : 11m	3h : 12m	6h : 27m	12h : 59m	
	16h : 44m	1d : 7h : 51m	2d : 19h : 28m	2h : 20m	4h : 44m	9h : 32m	
	6h : 58m	14h : 2m	1d : 4h : 9m	1h : 40m	3h : 23m	6h : 49m	
60 sec	15d : 00h : 46m	30d : 3h : 30m	60d : 12h : 37m	22h : 48m	1d : 21h : 54m	3d : 20h : 4m	
	4d : 14h : 56m	9d : 5h : 51m	18d : 14h : 35m	13h : 55m	1d : 4h : 00m	2d : 8h : 17m	
	2d : 14h : 40m	5d : 5h : 00m	252h : 22m	6h : 24m	12h : 55m	1d : 1h : 58m	
	1d : 9h : 28m	2d : 19h : 20m	10d : 12h : 57m	4h : 40m	9h : 28m	19h : 4m	
60 sec	13h : 57m	1d : 4h : 4m	2d : 7h : 18m	3h : 20m	6h : 46m	13h : 39m	
	90d : 4h : 40m	181d : 2h : 4m	362d : 20h : 44m	5d : 6h : 53m	11d : 11h : 27m	23d : 00h : 27m	
	27d : 17h : 40m	55d : 16h : 11m	111d : 14h : 32m	3d : 11h : 30m	7d : 00h : 16m	14d : 1h : 42m	
	15d : 16h : 00m	31d : 10h : 34m	63d : 2h : 17m	1d : 14h : 26m	3d : 5h : 34m	6d : 11h : 50m	
60 sec	8d : 8h : 52m	16d : 19h : 53m	33d : 17h : 43m	1d : 4h : 00m	2d : 2h : 51m	4d : 18h : 26m	
	3d : 11h : 42m	7d : 00h : 27m	14d : 9h : 53m	20h : 00m	1d : 16h : 38m	3d : 9h : 54m	

Data Acquisition and Recording Method Utilizing the Memory Function

The sophisticated memory of the DC100 can store measured data at the same time as transferring the data to a PC. If it is used for continuous data acquisition and recording with an external medium, the measured data stored in the PC can be saved on the external medium so that data can be backed up continuously. The DC100 inherits the portability of PC-based data loggers and the data acquisition and recording method of systems based on computerized databases.

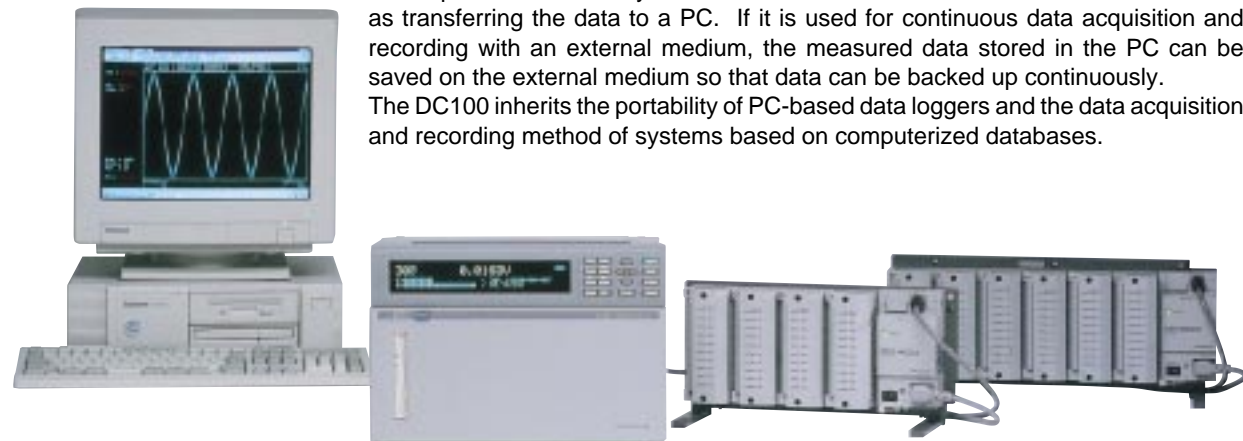

Computing functions

The main unit of the DC100 with optional MATH feature can perform the four arithmetic operations, integration of measured data, and computations such as detection of maximum and minimum values, in real-time. Even without the optional feature, the DC100 can compute linear scaling, difference and moving average. The results of such computations are transferred with the measured data to a PC, thus reducing system requirements on the PC and also resulting in more efficient analytical processing.

The main computing functions are as follows. (The shortest computation period differs depending on the kind of computation.)

●Standard computing functions

Linear scaling, moving average, differential calculation, pulse integration (with pulse input module).

●Optional functions (/M1)

The four arithmetic operations, logic operations, related operations, calculation of absolute and relative values, and statistical calculations (maximum, minimum, mean, and integrated values for fixed intervals)

●Moving average function

This function updates the measured value while calculating the moving average, thus effectively monitoring the trend of a varying input signal over a long period. It can also be used as a digital filter when noise components are present on the

input signal. You can set the number of moving average scans by selecting a value between 2 and 64.

●Batch integration

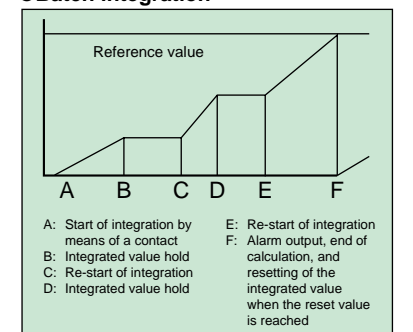

External Mass



/C5 : External Mass Storage Interface Function (SCSI-1*)

● Main Function

- By installing the external mass storage interface (SCSI) option to the DC100, you can connect MO / Zip / Jaz / PD disk drives.
- The external mass storage interface (SCSI) option is a communication interface for saving files (such as measurement data files, report files, and periodic files) created in the DC100 internal RAM to the MO / Zip / Jaz / PD disk.
- MO / Zip / Jaz / PD disks allow transferring of files between the DC100 and the PC without physically connecting the two using communication cables.

● /M3: Report Computation and Periodical Filing Function

The report computation function performs computations for hourly, daily, and / or monthly reports using the DC100 data collector, the results are recorded in the internal RAM.

The data file sampling intervals can be set different from the primary measuring interval. Both of the long-term trend recognition and short-term transient phenomena can be acquired with this option.

Data for both report computation results and multiple sampling interval file can also be stored on external memory media, such as floppy disk, MO or ZIP.

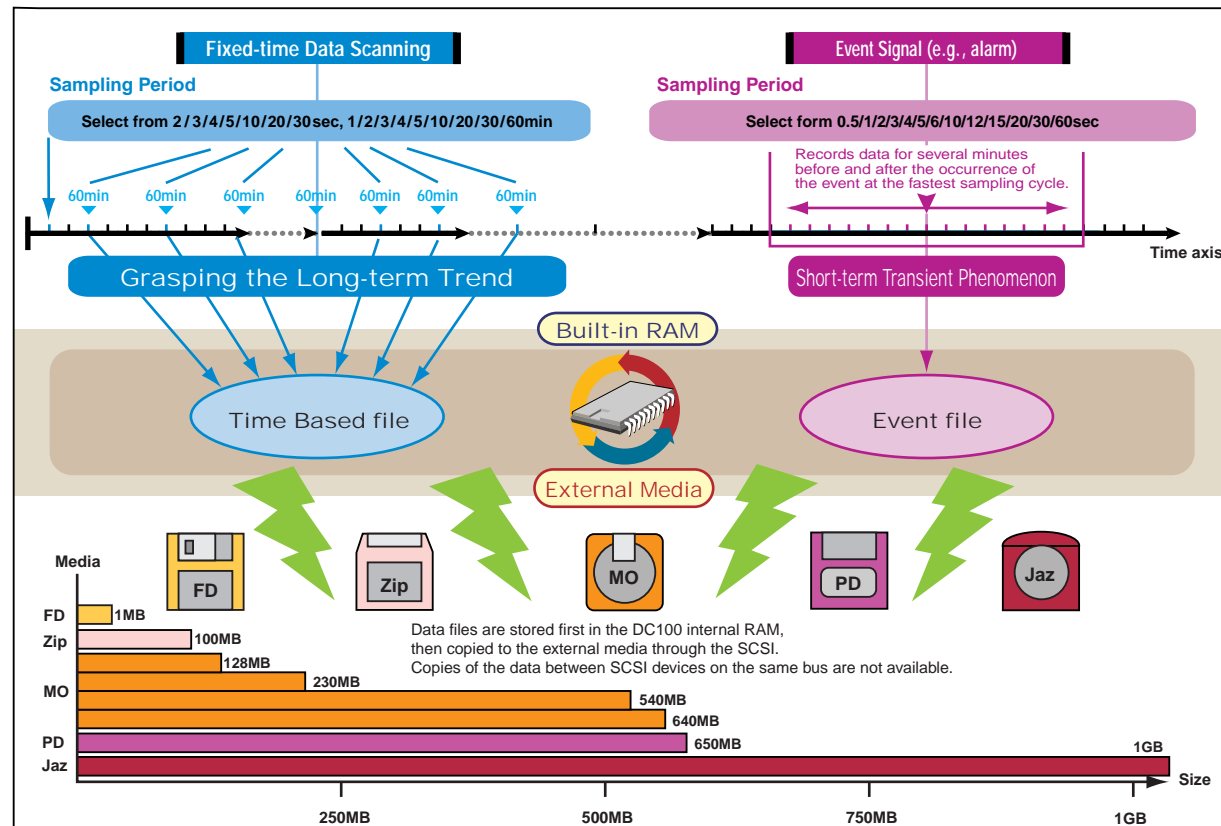

Wide Variety of Indications, and Ease of Operation Monitoring/setting functions

The DC100 comes with a large 3-line VFD display (22 large characters × 1 line and 40 small characters × 2 lines), allowing you to recognize data easily, even from a distance. The DC100 is operated interactively through

various guidance messages displayed on this VFD display for making settings. And the key layout is designed for true ease of use and rapid, error-free operations.

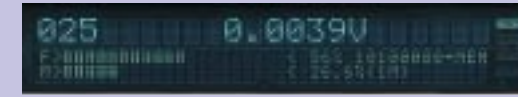

Top line: Automatic indication switching; mid line: remaining volume in the file; bottom line: remaining volume in the memory

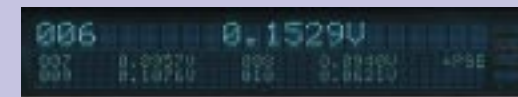

Top-mid-bottom lines: page (relational indication of all channels)



Top line: manual (selects the channel to be indicated.); mid line: bar graph; bottom line: date and time

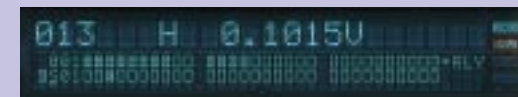

Top line: alarm search (indicates only the channels where an alarm is occurring); mid line: alarm status; bottom line: alarm relay status



Easy-to-identify Operation Keys

- ① **START, STOP:** Starts and stops the writing of measured data to the memory.
- ② **FD COPY:** Copies the data file in the main memory to the floppy disk.
- ③ **M. FUNC:** The user can assign the desired action-control function to this key.
- ④ **DISPLAY, MODE:** Selects the display line in the VFD and selects the display item on the selected line.
- ⑤ **CLOCK:** Sets the date and time.
- ⑥ **RANGE:** Sets up the input range of each channel or each group.
- ⑦ **ALARM:** Sets up the alarm function for each channel or each group.
- ⑧ **SET:** Sets up the measurement conditions (e.g., moving average, calculation, event/action, and unit settings).
- ⑨ **FUNC:** Sets up the operation conditions (e.g., calculation start/stop and keylock on/off settings).
- ⑩ **MEM SET:** Sets up the memory (e.g., number of divisions of the memory, data length setting, and storage method)

Simple operations using dialog

You can make settings easily using dialogs on the display which can display a total of 102 characters.

The setting item is always displayed in large characters at the top of the display, and the guidance message (auxiliary information), such as the setting range, is displayed in detail at the bottom of the display.

Also, items that are normally used frequently are grouped separately from items which, once set, are not changed frequently, thus simplifying routine operations.



Range setting screen

Crystallization of Technology

High performance and compactness resulting from YOKOGAWA's measurement and production technology provides you with cost-effective data acquisition

High Breakdown Voltage Solid State Relay (SSR)

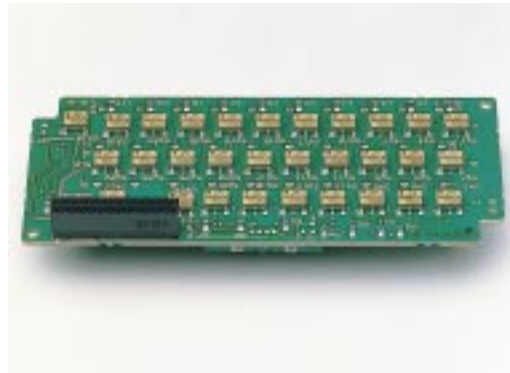

Developed by YOKOGAWA, the SSR switches the inputs for multi-channel measurement. A semiconductor device takes the place of the contacts and drive part of a mechanical relay, thus overcoming the problem of defective measurement caused by faulty or worn contacts of mechanical relays. YOKOGAWA's solid state relay has a high breakdown voltage (1500 VDC) enhancing safety in the field. Also, its low leakage current (1 nA) enables the very low level voltage signals from a thermocouple to be measured with high accuracy. YOKOGAWA currently uses this SSR in its hybrid recorders and the advanced μ R series of industrial recorders. Over 800 thousand channels of this technology have performed successfully in various field and laboratory applications, thus verifying the reliability of the relay device.

A new surface-mounted version of this highly reliable SSR is used in the DARWIN family. This permits a high degree of miniaturization, low power consumption, long device life and quiet operation.

ASICs and Gate Arrays

The DC100 uses ASICs (Application Specific Integrated Circuit) which YOKOGAWA developed with more than 40 years of data acquisition know-how. Also, a gate array is used as the peripheral control circuit. This high degree of integration makes the DC100 smaller and lighter, and reduces power consumption and heat generation, improving the reliability of the overall system.

Safety Standards, EMI and EMC Standards, Conformity to the CE Mark

The entire DARWIN family complies with the safety standards of North America. DARWIN components are also based on the CE mark, which certifies conformity to European safety standards and electromagnetic interference standards.

Safety standards: CSA C22.2 No.1010.1-92, IEC1010-1:1995, EN61010

EMI standard:EN55011: 1991, Group 1 class A

EMC standard:EN50082-2: 1995

Planar Transformer

A planar transformer is a revolutionary integrated transformer that is replacing the conventional wire-wound transformer, the most antiquated of all electronic components. This small, thin transformer consists of a multi-layer precision thin film coil that enhances insulation and reduces heat and noise emission. This compact, high-performance transformer enables the volume of the power supply unit to be reduced to just 1/2 to 1/5 that of previous power supply units.

All of the transformers in the main unit, subunits and input and output modules of the DC100 are planar transformers, thus greatly reducing the size and weight of the DC100.



Integration of the Design, Manufacturing and Quality Evaluation System

Routine installation work is automated, preventing careless mistakes during the production process from assembly through inspection. The result is a high grade, highly reliable product. We also use precision test equipment on the production line to further increase reliability.



DARWIN DAQ32 (standard)

DARWIN DAQ32 is the standard data acquisition software for common use with all the data gathering instruments in the DARWIN series. The software includes functions for hardware setup, simplified data logging, simplified data viewing, data conversion (Excel, Lotus 1-2-3 or ASCII format), preference setting, system diagnosis and calibration, all in one package. This software comes as standard in all models of the DA100 data acquisition unit and DC100 data collec-

tor. For each model of the DR130, DR230 and DR240 hybrid data recorders, you can specify whether or not the software is necessary when ordering. When specified as "necessary," the DAQ32 software comes as standard with the model.

DAQ32, which was developed for 32-bit operating systems, is designed to run under Windows 95, Windows 98 or Windows NT4.0.

DARWIN configuration software

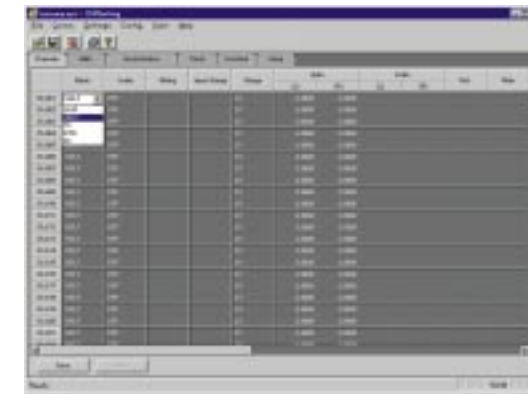

This software configures the DA100, DC100, and DR Series. Configurations can be uploaded / downloaded between DARWIN and your PC, including measurement ranges, measurement intervals, measurement TMstart times, alarms, events/actions, and MATH formulass. Settings can be stored on your PC's hard drive or a floppy disk for reuse. The setting screens use easy to view table formats.

System setup, diagnosis, and calibration software

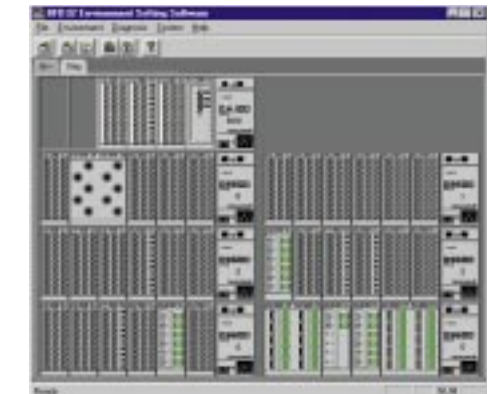

This software allows you to:

- (1) Set the communication mode to be used in communication with DARWIN.
- (2) Set the directory for data saving.
- (3) Display the DARWIN firmware version information.
- (4) Initialize the settings.

You can also graphically display the system configuration, including modules installed in DARWIN, and reconfigure the system as necessary when you change the modules installed in the DA100, DC100, or DR Series (expandable model). This software can also be used to calibrate DARWIN input modules.

Data logging software



Data logging software has a data display function for displaying measurements and computations, and a data acquisition function for periodically saving data to floppy disk or hard drive. Layout of analog trend, digital displays and other screen elements are operator selectable to optimize the screen for different applications or users. You can set as many as 2 groups, each containing the desired combination of measurement channels and computation channels (with 10 channels per group). Monitor display can be opened in order to simultaneously monitor data on 20 channels. DAQ32 also provides quick print function.

Data viewer software



You can display data that has been acquired by a logger and stored, in the form of a trend display, digital value display, or alarm information display.

In a trend display, you can use two cursors and display the values at the cursor positions and also display the results of statistical computation for the section between the cursors.

You can perform data analysis using a variety of tools such as the zoom function or the cursor step function.

You can convert stored data into the ASCII, Lotus 1-2-3®, or Excel® format while performing a zoom or scroll operation, thus facilitating data conversion.

DARWIN DAQ 32 Plus

DAQ32Plus is enhanced data acquisition software that can be used with all the data gathering instruments in the DARWIN series. Like the standard DAQ32, this software includes functions for hardware setup, data logging, data viewing, data conversion (Excel, Lotus 1-2-3 or ASCII format), preference setting, system diagnosis, calibration, and tag number setting, all in one package. But DAQ32Plus is far more powerful than DAQ32 in its data logging and monitoring functions, and also contains a wealth of additional functions not found in DAQ32. Additions include the display of up to 30 data groups each having a maximum of 32 channels' worth of data per window (compared with the DAQ32's display of up to 2 data groups each having up to 10 channels' worth of data per window); displays of various meters including level meters, analog meters and thermometers (not offered by DAQ32); alarm displays; as well as the DDE server, logger autostart, retry, and password functions. DAQ32Plus, which was also developed for 32-bit operating systems, is designed to run under Windows 95, Windows 98 or Windows NT4.0.

Data Logging Software

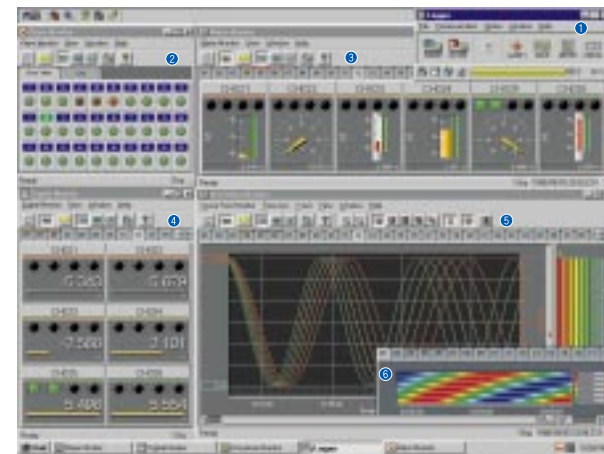

② Alarm overview

The alarm overview displays alarm statuses group by group. The alarms for all groups can be viewed at the same time so that you won't miss any alarms.

③ Meter display

Level meters, analog meters, and thermometers can be set as desired on each channel to create an effective monitor screen.

Data Viewer Software

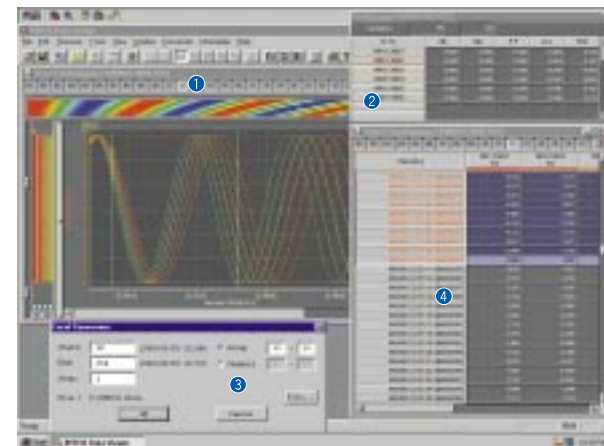

① Analog trend display

The analog trend display feature allows you to display up to 30 windows of channel data each containing as many as 32 channels. You can switch between the windows one at a time, and the color monitor display can also be used simultaneously.

① Monitor manager

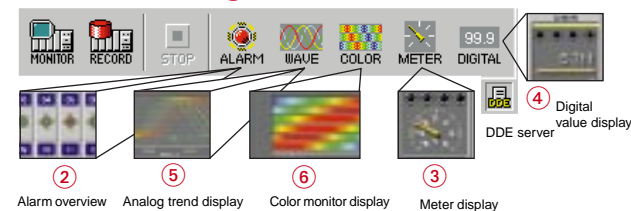

The monitor manager is used to start and stop logging, and to keep track of monitor group settings. The individual monitor windows are launched from the monitor manager.

④ Digital value display

Current values are displayed without modification in this area. This display is useful for acquiring detailed information when a problem occurs.

⑤ Analog trend display

This display presents measurement and computation value as analog trend. It can also "play back" the most recent 1800 data points / channel.

⑥ Color monitor display

The color monitor display allows measurements to be color-coded using as many as fifty color gradations from red to blue. This feature is useful for gaining a visual sense of temperature trends and making visual comparisons of measurements taken on multiple channels.

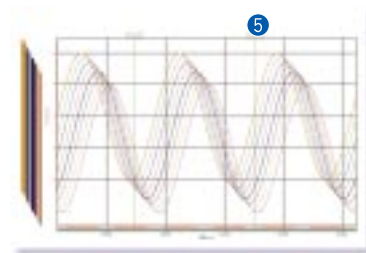

② Point to point statistics

Displays statistical computations for the data between the cursors.

③ Data conversion screen (Excel®)

Historical data can be converted to Lotus 1-2-3®(version 1A is supported), Excel®(version 4 is supported), and ASCII formats.

④ Digital value display

The digital value display feature allows you to display up to 30 windows of data each containing as many as 32 channels. You can switch between the windows one at a time.

⑤ Print preview (analog trend)

Displayed information can also be output to a color printer.

Process data logging software InTouch for DARWIN



InTouch for DARWIN is a dedicated data trending and logging package specifically designed for DARWIN data acquisition instruments. Jointly developed by Yokogawa Electric and industrial software leader Wonderware®, InTouch for DARWIN combines Yokogawa's extensive hardware experience with Wonderware's outstanding

human-machine interface (HMI) software technology. InTouch for DARWIN totally automates your HMI experience by integrating the InTouch graphical user interface, the DARWIN DDE I/O server, and DARWIN configuration software into a single "plug and play" software package.



Instrument group panel

This displays the instrument panels for one group of instruments. In the case of an analog input, the tag name, tag comment, process valuables (PV) value, alarm setting value (vertical indicator only) and alarm status (one of four levels HH, H, L or LL) are displayed. The display type is specified by the builder function (based on channel input type).

Alarm status/historical panel

This panel displays the PV alarm status of each channel. The displayed items are alarm generation/reset date and time, verification status, alarm type, channel No. and data values.

Group overview display

The inputs are divided into groups of 4, 8 or 16 items of data, and are displayed as a list. Up to 60 groups per screen (max. 480 points) can be displayed.

Channel overview panel

This panel displays logical tag numbers and tag comments corresponding to physical channel numbers. PV values are displayed digitally. If an alarm is generated in a channel, a red LED lights. One screen displays 60 channels in the physical channel sequence.

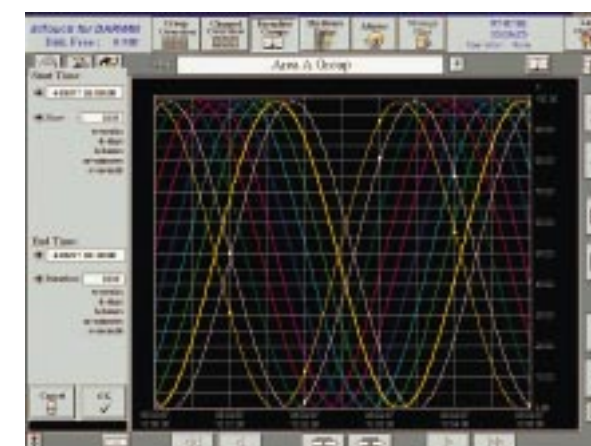

Historical trend panel

This panel displays a historical graph of the trend of the PV value for each tag No. (channel No.) corresponding to all inputs in a group (max. 16). The historical trend graph is displayed once the starting and end times have been set. The number of pens for the trend graph is 4, 8 or 16 pens, depending upon the size of the group. You can set the historical logging interval for each group, and display up to 6 weeks' worth of historical data. You can also enlarge, reduce or scroll the waveform.

Real-time trend panel

This panel displays a real-time graph of the trend of the PV value for each tag No. (channel No.) corresponding to all inputs in a group (max. 16). The number of pens for the trend graph is 4, 8 or 16 pens, depending upon the size of the group. You can set the display span as 1 minute or 5 minutes.

Individual channel real-time trend panel

This panel displays the instrument panel for one channel at a time, and also a trend graph of the PV value for that channel.

Measurement range (resolution):
 Voltage: 250 V (0.1 Vrms), 25 V (0.01 Vrms)
 Current: 5 A (0.001 Arms), 0.5 A (0.0001 Arms)
 Measurement accuracy: $\pm(0.5\%$ of span when RMS value of voltage and current is measured)
 Measured frequency: 45 to 65 Hz (all channels must have the same frequency)
 Crest factor: Maximum of 3
 Power integration: Calculated by /M1 (computation function) option. /M1 must be specified for the DC100.

Strain Measurement Modules

● Model, Number of Channels, Type of Terminal and Shortest Measurement Interval

Model	Number of Channels	Type of Terminal	Measurement Interval
DU500-12	10*, with built-in 120-Ω resistance	Clamp	0.5 s
DU500-13	10*, with built-in 350-Ω resistance	Clamp	0.5 s
DU500-14	10*, for external bridge box	NDIS	0.5 s

*: Occupies the width of two modules.

General Specifications

Measurement range (resolution): 2,000 μe (0.11 μe)
 20,000 μe (1 μe)
 200,000 μe (10 μe)
 Built-in bridge resistance: 120 Ω , 350 Ω , or none (for an external bridge box)
 Wiring: 1/4 bridge 1/2 bridge (neighbor), 1/2 bridge (opposite), full bridge
 Applicable gauge resistance:
 1/4 or 1/2 bridge: 120 or 350 Ω
 Full bridge: 100 to 1,000 Ω
 Bridge voltage: Fixed at 2 V
 Gauge factor: 2.00 (with scaling function)
 Strain balance: Electronic auto-balancing (can be turned on or off), within $\pm 10,000 \mu\text{e}$ (1/4 bridge)

Pulse Measurement Modules

● Model, Number of Channels, Type of Terminal and Shortest Measurement Interval

Model	Number of Channels	Type of Terminal	Measurement Interval
DU600-11	10	Screw	0.5 s*

*: Rate of data update is fixed at 1-second intervals.

General Specifications

Input method: Shared common line within the same module
 Type of input: Non-voltage contact or open collector (TTL or transistor)
 Measurement modes
 RATE (count value instantaneous mode): The number of pulses input during the most recent 1-second period of measurement is output as the scale set value.
 GATE (ON time instantaneous mode): The ON (make)/OFF (break) state (ON = 1, OFF = 0) of the contact input during the most recent 1-second period of measurement is output as the scale set value.
 Pulse integration: The computation function is used when integrating either the count value each second or the ON period.
 Computation formula: TLOG.PSUM (XXX)
 Number of computation channels: Max. 30 channels for stand-alone model
 Max. 60 channels for expandable model
 Max. count value/ON period: 99999999
 (/M1 (computation option) need not be specified for the DC100 main unit. Pulse integration can be used automatically when a pulse module is recognized.)
 Maximum input frequency: 6 kP/s (10 P/s for voltage-free contact)
 Filter: For rejection of chattering up to 5 ms (can be turned on and off for every channel)

DC Current Input Modules

● Model, Number of Channels, Type of Terminal and Shortest Measurement Interval

Model	Number of Channels	Type of Terminal	Measurement Interval
DU300-11	10	Screw	0.5 s
DU300-12	10	Clamp	0.5 s

General Specifications

Input method: Floating imbalance input, and inter-channel isolation
 Shunt resistor (100 Ω) is pre-installed.
 A/D resolution: $\pm 20,000$
 A/D integration time: Manual selection or automatic switchover between 20 ms (50 Hz), 16.7 ms (60 Hz) and 100 ms (10 Hz)
 Measurement range and resolution: $\pm 20 \text{ mA}$ (1 μA)
 Noise rejection: By means of integrating A/D, low-pass filter or moving average
 Minimum measurement interval when the low-pass filter is working becomes 3 s (depends on the input modules).

● Model, Number of Channels, Type of Terminal and Shortest Measurement Interval

Model	Number of Channels	Type of Terminals	Measurement Interval
DU700-11	10	Screw	0.5 s

General Specifications

Input method: Floating unbalanced input, each channel mutually isolated (channel independent)
 The RTD range has a common potential (terminal b).
 A/D resolution: ± 20000

A/D integration time: 20 msec.(50Hz), 16.7 msec.(60Hz), 100 msec.(10 Hz)
 Maximum allowable input voltage:
 DI (CONT) / $\pm 10\text{VDC}$
 DI (LEVEL) / $\pm 60\text{VDC}$
 Insulation resistance: Min. 20M Ω at 500VDC between the input terminal and ground
 Input bias current: Max.10 nA

Alarm, DI/DO and Other Modules

Alarm Contact Output Modules

● Model, Number of Outputs, Contact Mode and Type of Terminal

Model	Number of Outputs	Contact Model	Type of Terminal
DT200-11	4	C contact (NO-C-NC)	Screw
DT200-21	10	A contact (NO-C)	Screw

General Specifications

Output mode: Selection between excitation and non-excitation, output hold and non-hold and AND and OR modes
 Re-breakdown re-alarm: Maximum of 6 contacts can be selected.
 Contact capacity: 250 VDC/0.1 A (resistive load)
 30 VDC/2 A (resistive load)
 250 VAC/2 A (resistive load)

Withstanding Voltage:

Between output terminal and ground: 1,500 VAC (50/60 Hz) for one minute

DI/DO Modules

Common Specifications

Model: DT100-11
 Up to one module can be connected to one DC100 system.

Alarm Contact Output

Number of outputs: 2
 Contact mode: C contact—NO-C-NO terminal
 Contact capacity: 250 VDC/0.1 A (resistive load)
 30 VDC/2 A (resistive load)
 250 VAC/2 A (resistive load)

Fail Output

Function: If an abnormality is found in the total system, the fail output terminal is de-energized.
 A contact. Cannot be switched between excited and non-excited.

Output mode:

250 VDC/0.1 A (resistive load)
 30 VDC/2 A (resistive load)
 250 VAC/2 A (resistive load)

Remote control function

Starting, resetting and temporary hold of statistical computation
 Input signal: Non-voltage contact or open collector (TTL or transistor)

Extension Modules (used with extension base units)

Unit to connect with: DC100-2, DS400 or DS600 (one for each unit)
 Number of input modules: One input module can be mounted on an extension base unit and up to 3 extension base units can be connected to an extension module in series.
 However, the number of input modules connected to an extension module and the number of input/output modules directly connected to a main or subunit where the extension module is connected must not exceed the total number of modules that can be connected to the subunit.
 Extensible distance: Within an overall length of 30 m
 Connectable input module: 10 ch universal input module
 10 ch DCV/TC/DI input module

Communications Modules

Functions, Common Specifications

Outline of functions:
 (1) Functions as a talker
 Output of measured values, output of setting values
 (2) Functions as a listener
 Setup of measurement conditions, control of start/stop of measurement, etc.
 Withstanding voltage: 1,500 VAC (50/60 Hz) for one minute between output terminal and ground

GP-IB Modules

Electrical and mechanical specifications: Based on IEEE standard 488-1978
 Addresses: 0 to 15

RS-232-C Modules

Electrical and mechanical specifications: Based on EIA RS-232-C
 Communications format: Half duplex
 Synchronization: Start-stop synchronization (synchronization by means of the start and stop bits)

Baud rate: 150, 300, 600, 1200, 2400, 4800, 9600
 19200, 38400 bps
 Maximum of 15 m

Connector: D-sub 25-pin connector

Transmission distance: Maximum of 15 m

Connector: D-sub 25-pin connector

● RS-422A/485 Modules

Electrical and mechanical specifications: Based on EIA RS-422-A and EIA RS-485

Connection method: Multi-drop

Address: 1 to 31

Communications format: Half-duplex, 4-wire method/2-wire method

Synchronization: Start-stop synchronization (synchronization by means of start and stop bits)

Baud rate: 300, 600, 1200, 2400, 4800, 9600,
 19200, 38400 bps
 Maximum of 1200 m

Transmission distance: Maximum of 1200 m

Connector: 6-screw terminal

● Ethernet Modules

Electrical and mechanical specifications: Conform to standard IEEE802.3

Number of communication port: 1

Connection method: Ethernet

Transfer specification: 10 Base-T (CSMA/CD, 10Mbps, Base band)

Transfer speed: 10 Mbps

Communication protocol: TCP, UDP, IP, ARP, ICMP

PC number that is able to gain access to 1 Darwin unit:

Max. 4units
 ASCII Supports all the commands of RS-232-C module (DT300-21)

Output data: ASCII, Binary

Software Section

DARWIN DAQ32

Model	OS	PC type
DP120-11	Windows 95/98/NT4.0	IBM PC/AT Compatible Models.

System Requirements

Personal Computer: A personal computer with either a Microsoft Windows 95, Windows 98, or Windows NT 4.0 operating system.

● For DAQ 32 (model code DP120-11), a pentium MMX 133 MHz or higher is required (pentium-II recommended) for the processor.

● For DAQ 32 Plus (model code DP320-11), a pentium MMX 166 MHz or higher is required (pentium-II recommended) for the processor.

RAM: At least 32 megabytes (MB)(64 MB or larger recommended)

Hard Disk: 100 MB of free hard disk space is required for installation.
 The program size is 10 MB

MS and MS-DOS are registered trademarks of Microsoft Corporation USA.
 Excel is a registered trademark of Microsoft Corporation USA.
 Windows is a registered trademark of Microsoft Corporation USA.
 IBM and IBM PC/AT are registered trademarks of International Business Machines Corp.
 Lotus 1-2-3 is a registered trademark of Lotus Development Corporation.
 Pentium is a registered trademark of Intel Corporation USA.
 Ethernet is a registered trademark of XEROX Corporation USA.
 AT-GPIB is a registered trademark of National Instruments.
 HP-PCLV is a registered trademark of Hewlett-Packard Corp.
 Other company and/or product names are registered trademarks of their respective manufacturers.

DC100 main unit

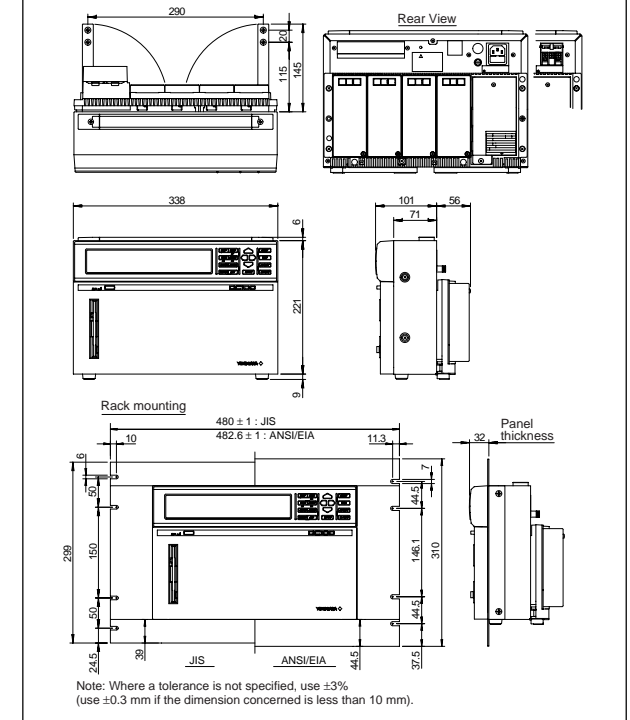

DV250-001 Cable Adapter

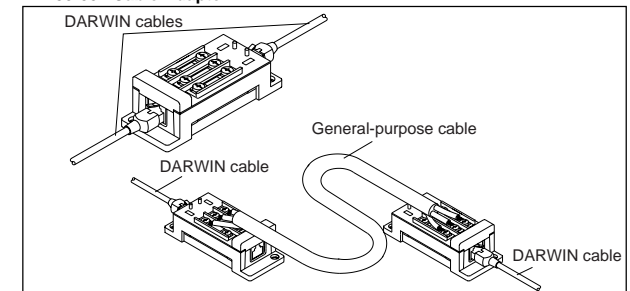

The DV250-001 cable adapter can be used at each joint of DARWIN cables to extend the overall length. Cables other than DARWIN cables can be used to connect between two DV250-001 cable adapters.

DS600

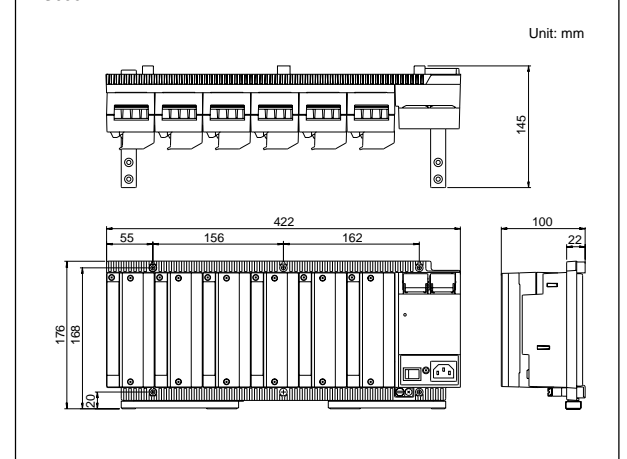

DS400

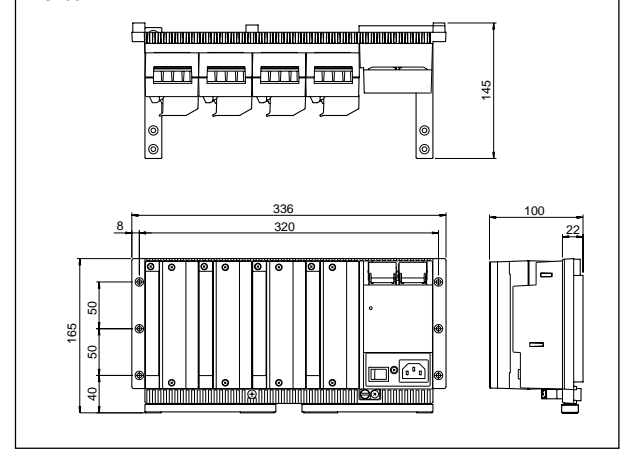

Panel mount fittings for DC100

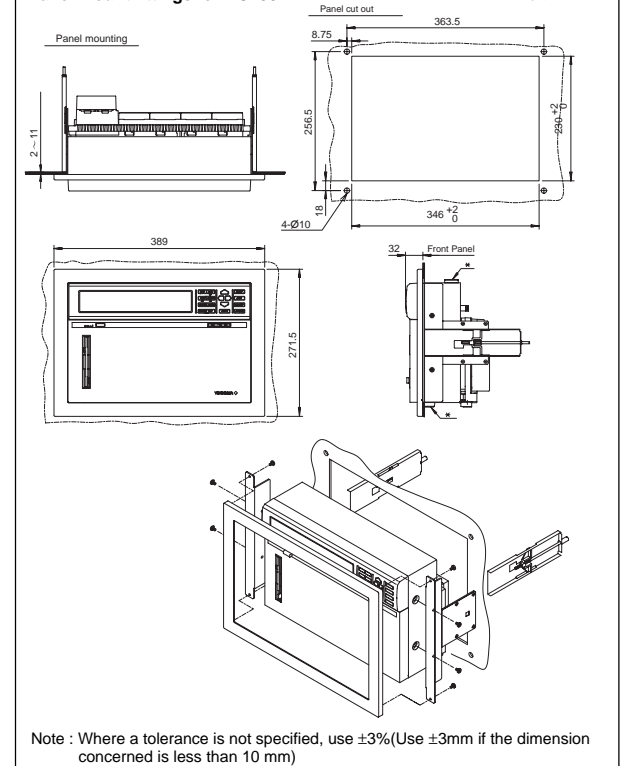

Models and Suffix Codes

DC100 Main Unit

Model	Suffix code	Optional Code	Description
DC100			Data collector
Type	-1		Stand-alone type
	-2		Expandable type main unit
Software	2		DARWIN DAQ32 (English)
Memory	-1		Internal memory 1M byte (standard specification)
	-2		Internal memory 2M byte
	-3		Internal memory 4M byte
FDD	1		Floppy disk drive
Power supply voltage	-1		100V AC to 240V AC
	-2		12V DC to 28V DC (Standard : AC adapter)*1
Power inlet & power cable	D		3-pin power inlet w/UL,CSA cable
	F		3-pin power inlet w/VDE cable
	R		3-pin power inlet w/SAA cable
	S		3-pin power inlet w/BS cable
	W		3-pin power inlet w/screw terminal*2
Optional feature	/M1		Mathematical function
	/M3		Report and Periodical Filing function
	/C5		External Mass Storage Interface function
	/D2		F degree display
	/L1		Summer/winter time

*1 All DC-powered models having this suffix code come with an AC adapter as standard. Choose the type of power cable of the AC adapter from the suffix codes D, F, R and S.

*2 This suffix code cannot be specified for any DC-powered model.

(1) The DARWIN extension cable must be ordered separately when the expandable model is specified.

(2) The subunit and input/output module must be ordered separately when the expandable model is specified.

DS400/DS600 Subunit

Model	Suffix code	Description
DS400		4-module connection subunit
DS600		6-module connection subunit
Type	-00	Always 00
Supply voltage	-1	100 V AC to 240 V AC
	-2	12 V DC to 28 V DC
Supply section inlet socket, power cable	D	3-pin inlet w/UL, CSA cable
	F	3-pin inlet w/VDE cable
	R	3-pin inlet w/SAA cable
	S	3-pin inlet w/BS cable
	W	3-pin inlet, with screw conversion terminal
	Y	DC power supply specify

Input Modules

Model	Description	Required No. of slots	Terminal	Maximum measurement period
DU100-11	10 ch universal input (DCV, TC, DI and RTD)	1	Screw	0.5 s
DU100-21	20 ch universal input (DCV, TC, DI and RTD)	2	Screw	2 s
DU100-31	30 ch universal input (DCV, TC, DI and RTD)	3	Screw	2 s
DU100-12	10 ch universal input (DCV, TC, DI and RTD)	1	Clamp	0.5 s
DU100-22	20 ch universal input (DCV, TC, DI and RTD)	2	Clamp	2 s
DU100-32	30 ch universal input (DCV, TC, DI and RTD)	3	Clamp	2 s
DU200-11	10 ch DCV/TC/DI input	1	Screw	0.5 s
DU200-21	20 ch DCV/TC/DI input	2	Screw	2 s
DU200-31	30 ch DCV/TC/DI input	3	Screw	2 s
DU200-12	10 ch DCV/TC/DI input	1	Clamp	0.5 s
DU200-22	20 ch DCV/TC/DI input	2	Clamp	2 s
DU200-32	30 ch DCV/TC/DI input	3	Clamp	2 s
DU300-11	10ch mA input module	1	Screw	0.5S
DU300-12	10ch mA input module	1	Clamp	0.5S
DU400-12	Power monitor module for single phase	1	Clamp	2S
DU400-22	Power monitor module for 3 phase	1	Clamp	2S
DU500-12	10ch strain input module (120 Ω)	2	Clamp	0.5S
DU500-13	10ch strain input module (350 Ω)	2	Clamp	0.5S
DU500-14	10ch strain input module (External bridge box)	2	NDIS	0.5S
DU600-11	10 ch pulse input	1	Screw	0.5 s
DU700-11	10 ch DI input	1	Screw	0.5 s

I/O Terminal Modules

Model	Description
DT100-11	DI/DO module (2 alarm outputs, remote control signal input, fail/chart end output)
DT200-11	Alarm output module (4 transfer contacts)
DT200-21	Alarm output module (10 make contacts)
DT300-11	GP-IB module
DT300-21	RS-232C module
DT300-31	RS-422-A/485 module (screw terminal)
DT300-41	Ethernet module (10 Base-T)

Accessories

Model	Description
DV100-011	DARWIN Extension module
DV100-012	DARWIN Extension base unit
DV200-000	DARWIN Extension cable (0.5 m)
DV200-001	DARWIN Extension cable (1 m)
DV200-002	DARWIN Extension cable (2 m)
DV200-005	DARWIN Extension cable (5 m)
DV200-010	DARWIN Extension cable (10 m)
DV200-020	DARWIN Extension cable (20 m)
DV200-050	DARWIN Extension cable (50 m)
DV200-100	DARWIN Extension cable (100 m)
DV200-200	DARWIN Extension cable (200 m)
DV200-300	DARWIN Extension cable (300 m)
DV200-400	DARWIN Extension cable (400 m)
DV200-500	DARWIN Extension cable (500 m)
DV250-001	Cable adapter
DV300-011	Shunt resistance, 10 Ω, for screw
DV300-012	Shunt resistance, 10 Ω, for clamp
DV300-101	Shunt resistance, 100 Ω, for screw
DV300-102	Shunt resistance, 100 Ω, for clamp
DV300-251	Shunt resistance, 250 Ω, for screw
DV300-252	Shunt resistance, 250 Ω, for clamp
DV400-011	Rack mounting kits for DA100, DS400/DS600
DV400-015	Rack mounting kits for DC100, DR130
DV400-071	Panel mounting kits for DC100
DV450-001	Strain conversion cable (DIS-NDIS)
DV500-001	AC adapter for DC100/DS400/DS600 (DC power supply)

Package Software

Model	Description
DP120-13*	DARWIN DAQ 32 software (Windows95/98/NT 4.0)
DP300-13	Enhanced data logging software (Windows3.1/95/98)
DP320-13	DARWIN DAQ 32 Plus software (Windows95/98/NT 4.0)
DP350-13	Enhanced multi data logging software (Windows3.1/95/98)
DP380-13	Report software for /M3 report function (Windows3.1/95/98)
DP800	InTouch for DARWIN (Windows95/NT)
DP801	Report out put package for InTouch for DARWIN (Windows95/NT)

*when purchasing the DA100, the DP120-13 is attached as standard accessory.

Configuration example of the expandable model

- 100 ch, 0.5 s universal input, with GP-IB and 20 ch alarm output
- DC100 expandable main-unit: DC100-2 × 1
- Sub unit: DS600 × 1
- Sub unit: DS400 × 1
- Universal input module: DU100-11 or -12 × 10
- Communication module: DT300-11 (GP-IB) × 1
- Alarm output module: DT200-21 × 2
- DARWIN Extension cable × 2

NOTICE

- Before operating the product, read the instruction manual thoroughly for proper and safe operation.
- If this product is for use with a system requiring safeguards that directly involve personnel safety, please contact the Yokogawa sales offices.



YOKOGAWA ELECTRIC CORPORATION

Measurement Sales Dept./Phone: 81-422-52-6614, Fax: 81-422-52-6624

Recorders · DAC Sales Dept./Phone: 81-422-52-6765, Fax: 81-422-52-6793

YOKOGAWA CORPORATION OF AMERICA

YOKOGAWA EUROPE B.V.

YOKOGAWA ENGINEERING ASIA PTE. LTD.

Phone: 770-254-0400, Fax: 770-251-6427

Phone: 31-33-4-641611, Fax: 31-33-4-631202

Phone: 65-783-9537, Fax: 65-786-6650

Subject to change without notice.

[Ed : 02/b] Copyright ©1997

Printed in Japan, 812(YG)

MRS-05E